



Passport and instruction manual for Ecosoft undercounter drinking water filter

Technischer Datenpass und Bedienungsanleitung für Einbaufilter zur Reinigung von Trinkwasser

Паспорт та інструкція з експлуатації вбудовуваного побутового фільтра для очищення питної води

Паспорт и инструкция по эксплуатации встраиваемого бытового фильтра для очистки питьевой воды

Caracteristici tehnice și manualul de utilizare a filtrului incorporabil de uz casnic pentru apa potabilă

Pasoš i uputstvo za upotrebu filtera pike vode Ecosoft za ugradnju na kuhinjski element ili sudoperu

Паспорт и ръководство за експлоатация на филтър за питейна вода Ecosoft за вграждане под мивката

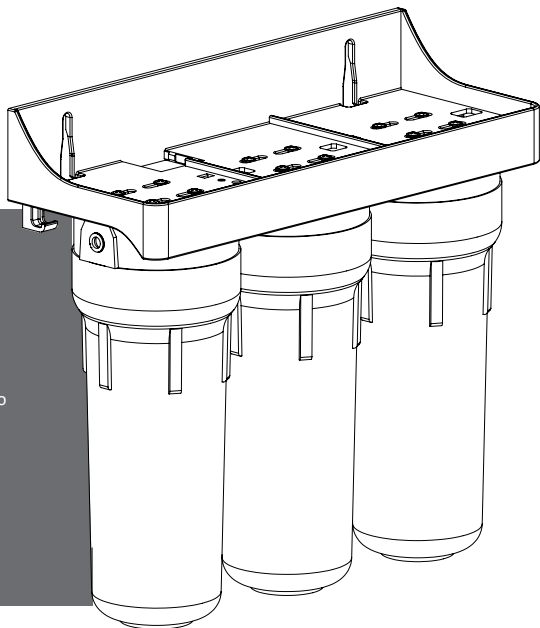

Dear customer!

Thank you for choosing our products.

We want you and your family to enjoy clean drinking water. With Ecosoft filter you will forget the trouble of using large bottles. Pure spring water for drinking, cooking and making drinks will always be at hand. Please read this instruction manual and check validity of the warranty card before using the system.

Operating conditions

ENG

Overall dimensions, (L x D x H), mm inch	400 x 135 x 350 15.8 x 5.3 x 13.8
Gross weight / Net weight ($\pm 5\%$), kg pounds	5.3/5.0 11.7/11
Operating pressure, bar psi	2-6 29-87
Temperature of feed water, °C °F	+4...+43 39...109
Distance between screw holes, mm inch	267 10.5

Filter assembly

1. Filter with bracket for mounting on the wall
2. Drinking water faucet
3. Colored flexible tubes (2 pieces)
4. Feed adapter for connecting to water supply (1/2" male thread – 1/2" female thread – 1/4" female thread)
5. Adapters for feed adapter (3/8" male thread – 3/8" female thread)
6. Feed water valve (1/4" male thread – 1/4" compression fitting)
7. Bowl wrench
8. Locking clip

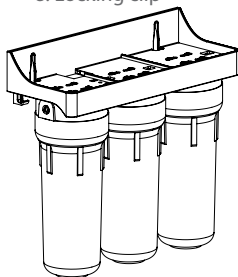

1. Filter with bracket

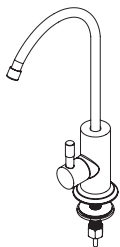

2. Drinking water faucet



3. Colored tubes



4. Feed adapter

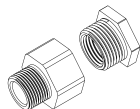

5. Adapters for feed adapter *

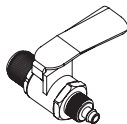

6. Feed water valve

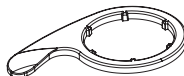

7. Bowl wrench



8. Locking clip

The manufacturer reserves the right to modify product design or specific components, if such modification does not entail deterioration of consumer properties of the product.

* Can be included into filter assembly of some models.

Filter installation manual

ENG

1. Shut off water supply in your apartment or kitchen and open water tap at the installation site in order to relieve pressure in your system.
2. Install the feed adapter into your cold water line (consult diagram on page 11). Use PTFE tape for sealing threaded connections. If your cold water line is 3/8" size please use 3/8" adapters. (consult diagram on page 11).
3. Screw the feed water valve into feed adapter 1/4" female thread. Connect red tube to the compression fitting of the feed water valve (see diagram on page 11).
4. Install the drinking water faucet (see instruction on page 9).
5. Identify the spot on the wall where you are going to install the filter, make two holes spaced apart. Allow for at least 100 mm (3.94") elevation of the bottom of your filter above the floor. Install screw anchors if necessary and screw in two screws (not included).
6. Connect the flexible tubes (see on page 10).
7. Shut off feed water valve and restore water supply to the site of installation. Ensure the drinking water faucet is opened and start to open the feed water valve slowly letting air out of the system. After the air has escaped adjust the feed water valve to a flow rate of 1 liter (0.25 gpm) per minute.
8. Leave the drinking water faucet open for 30 minutes. Close the drinking water faucet and inspect every connection for leaks. If leaks are not detected, the filter is ready for use.

Guide to using your Ecosoft filter

The filter is designed for treating cold water only!

Do not exceed the recommended water flow rate of 1 liter (0.25 gpm) per minute, or water quality will deteriorate.

In case of prolonged downtime, perform disinfection procedure first before continuing to use the system per guidelines on page 7.

Do not use disposable cartridges longer than recommended service life (or exceed total water amount). Feed water quality may significantly affect cartridge capacity.

The manufacturer strongly recommends installing a pressure regulator, if your water pressure may exceed 5 bar (72 psi) at any time. Pressure surges may also result from water supply interruption.

Disinfection procedure for Ecosoft drinking water filter. Maintenance

The manufacturer recommends to use the services of a qualified professional for water treatment system disinfection. Disinfection of water treatment systems is to be performed in case the filter has not been used for 2 weeks or longer.

Disinfection is also desirable when the cartridges are replaced. Use non-flavored 5.25 % household chlorine bleach based on sodium hypochlorite. In order to perform filter disinfection proceed as follows:

1. Shut off feed water valve.
2. Open drinking water faucet and drain all water from the filter.
3. Remove the cartridges from their housings (recycle used cartridges if changing).
4. Screw on the second and third bowl.
5. Pour 50 ml (1 qt) of chlorine bleach into the first bowl, screw it on and tighten the bowl.
6. Open drinking water faucet.
7. Open feed water valve.
8. When water running from the faucet begins to smell like chlorine, close the faucet and shut off the feed water valve.
9. Leave for 23 hours.
10. Open drinking water faucet and feed water valve. Flush the filter until you can no longer smell chlorine, then close both feed water valve and the faucet.
11. Wash your hands with antibacterial soap.
12. Install new cartridges into the system.
13. Open feed water valve (adjust to a 1 liter per minute flow (0.25 gpm)).
14. Monitor the filter over the next 2 hours, making sure no leaks appear at connections.

Faucet installation

To begin installing the faucet drill a hole with a diameter of 12.5 mm (1/2") in a suitable place on the kitchen sink or counter.

Assemble the faucet on the countertop by first putting the rubber gasket on top of the hole and seating the faucet in it. Put on plastic gasket, lock washer, and nut on the faucet shank sticking through at the bottom side of the hole. Screw the nut all the way up until the faucet is firmly fixed on the countertop.

Take the blue tube, put compression nut on it, put on compression ring, then put plastic insert inside the blue tube (in that order).

Push the blue tube into the bottom of the faucet shank ensuring the compression ring is stuck in the bottom of shank. Screw on the compression nut in order to join the tube to the faucet.

After completing the installation the faucet must be firmly fixed on the countertop, and the blue tube firmly joined to the threaded connection of the faucet.

Attention! Metal chips can damage the sink, it is necessary to remove them carefully after the hole is drilled. If you are installing the faucet on a ceramic or stone fixture, use a special carbide drill bit.

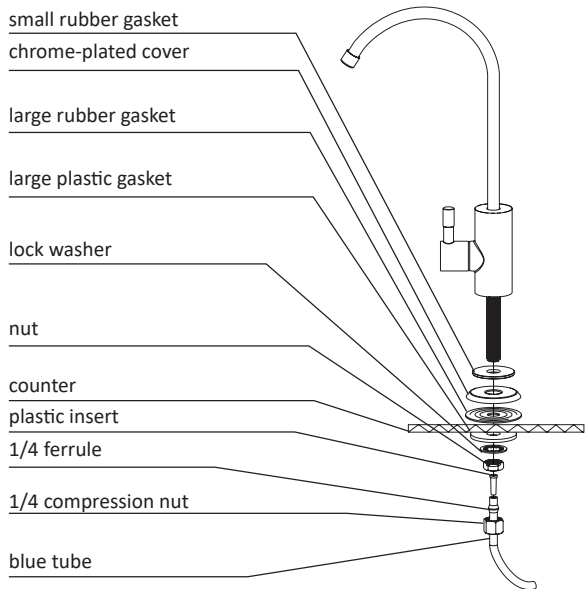

Connecting flexible tubes

Connecting the flexible tubes does not require using any tools. The entire system is connected together per scheme on page 11.

1. In order to join tube to fitting simply push the tube all the way into the fitting.
2. After you have joined the tube, put on a locking clip (horseshoe-shaped red plastic clip) under the collet to secure the connection.
3. Check the connection you have made by pulling on the tube in outward direction.
4. If you need to release tube from connection, take off the locking clip (a), push the collet back against the fitting (b), and then gently pull out the tube (c), while keeping the collet depressed.

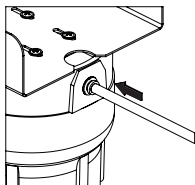

1

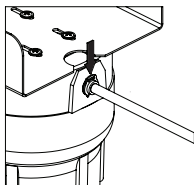

2

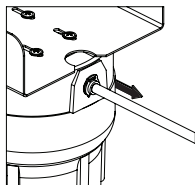

3

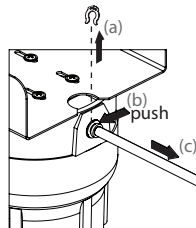

4

Tube connection

Tube disconnection

Filter installation diagram

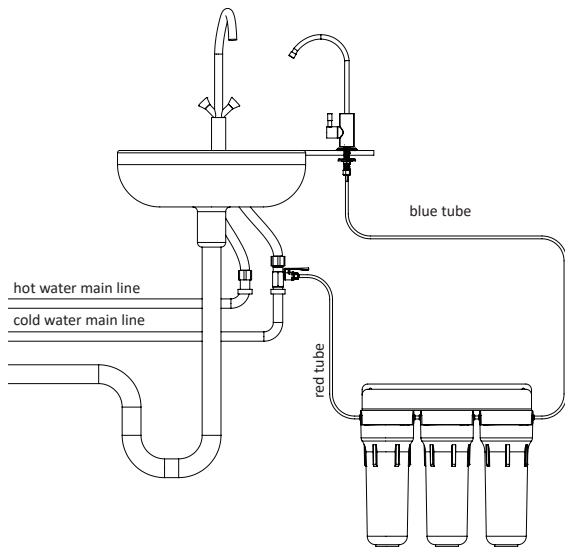

Connecting feed adapter and valve

1/2" water line

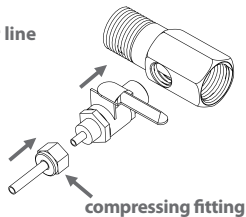

3/8" water line

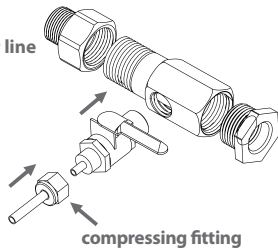

Replacing the cartridges

The procedure applies to all cartridges. All the filter cartridges should be replaced at once. Below is explained the procedure for replacing cartridges (see diagram on page 13):

1. Shut off feed water valve and open drinking water faucet to relieve pressure.
2. Unscrew filter bowl with a wrench. Take care as the bowl is filled with water.
3. Remove the used cartridge.
4. Wash the filter bowl thoroughly.
5. Perform disinfection procedure, following the guide on page 7.
6. Put the new cartridge into the bowl with the rubber gasket on top. Make sure the O-ring seal is properly seated in the groove inside the bowl.
7. Screw on the bowl. Bowls should be screwed by hand, without using wrench.
8. While keeping the faucet open, slightly open feed water valve. Allow the air to purge from the system, then adjust feed water valve to let through 1 liter (1 quart) of water per minute.

Cartridge placement scheme

Choose Option 1 or Option 2 of cartridge placement depending on your set of cartridges.

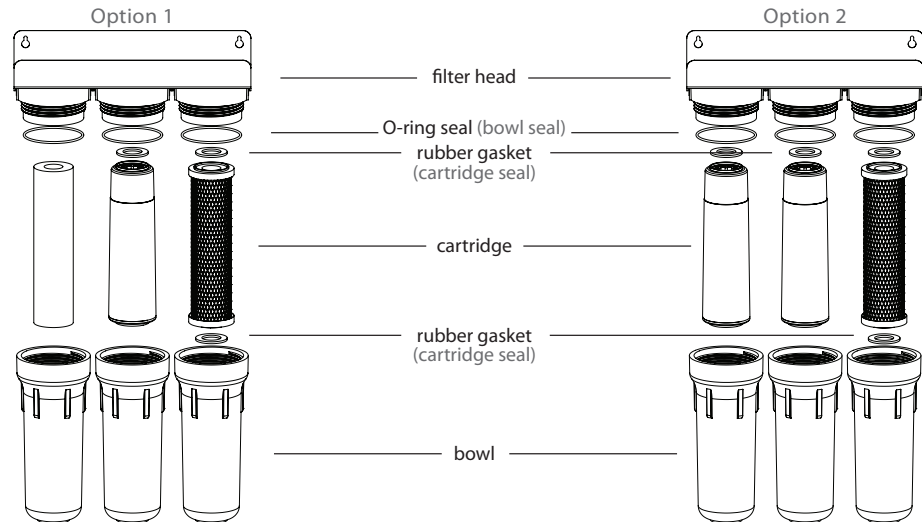

Warranty

The warranty is valid for 12 months from the date of purchase, provided that the operating conditions specified in this instruction manual are adhered to.

Warranty does not cover replacement filter, defects that have not been reported during warranty period and defects resulting from misuse of the product.

Complaints may be filed on the basis of a filled out warranty card and a receipt or bill to confirm purchase.

The vendor shall not be held liable for any property damage or other loss, including lost profits, accidental or due to use or inability to use this product. Liability of the vendor shall not exceed value of the product.

Cases not covered under this warranty will be resolved according to relevant legislation.

Warranty period:

12 months from the date of purchase from a retail establishment (unless otherwise specified in the product warranty card).

The service life of the filter housing — 5 years. Store at temperatures from +5 to +40 °C (41...104 °F).

Warranty card

Only original warranty card is valid if there is cash and/or sales receipt.

Name of product: water purification filter

Name and stamp of the dealer:

Date of sale: